

# HF

Halogen Free

REV.	ECN NO.	LOCATION	DESCRIPTION	DATE	DESIGN
A			INITIAL RELEASE	07/06'21	ZC.XIE

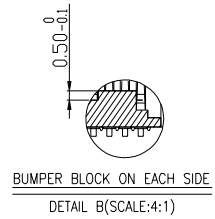
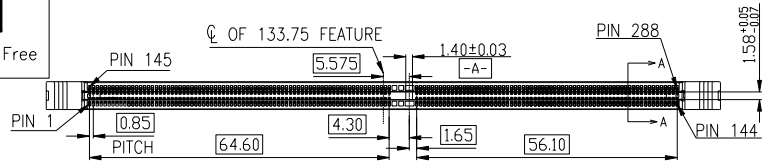

- NOTES:
- PRODUCT MUST MEET CONTROLLED SUBSTANCES SPEC. ROHS 2.0
  - 1. MATERIAL:
    - 1.1 HOUSING: NYLON , UL94V-0; COLOR: SEE TABLE.
    - 1.2 EXTRACTOR: NYLON ,UL94V-0;COLOR: SEE TABLE.
    - 1.3 CONTACT: COPPER ALLOY .
    - 1.4 FORK LOCK: STAINLESS STEEL.
  - 2. FINISH:
    - 2.1 CONTACT:
      - GOLD PLATING(SEE TABLE.) ON CONTACT AREA.
      - 2.0um[80u"] MIN. MATTE-TIN PLATING ON SOLDER TAIL AREA.
      - 2.25um[90u"] MIN. NICKEL ON CONTACT AREA,
      - 1.27um[50u"] MIN. NICKEL ON OTHER AREA
    - 2.2 FORK LOCK:
      - MATTE TIN PLATING 80u"Min ON SOLDER TAIL AREA.
      - 50u" MIN. NICKEL UNDERPLATING OVERALL.
  - 3. REFLOW SOLDER CAPABLE TO 260°C MAX. 10S.

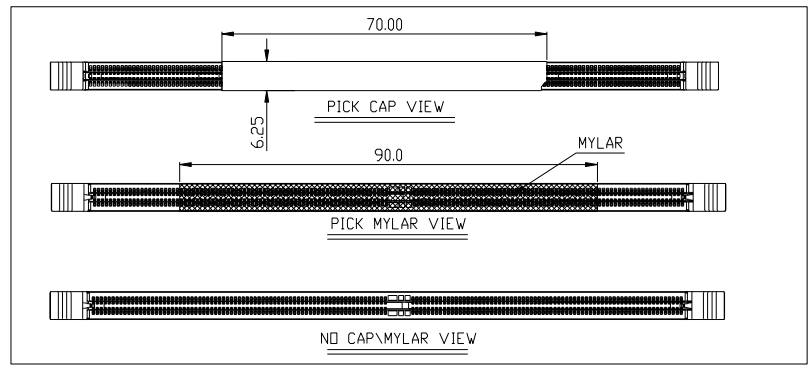
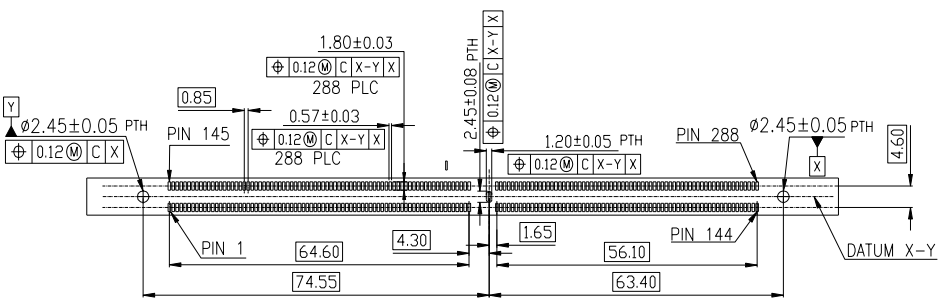
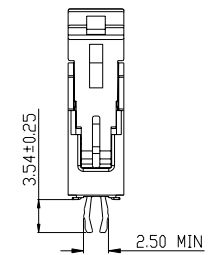
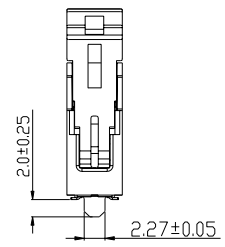
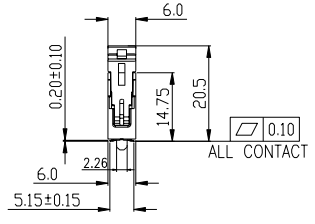
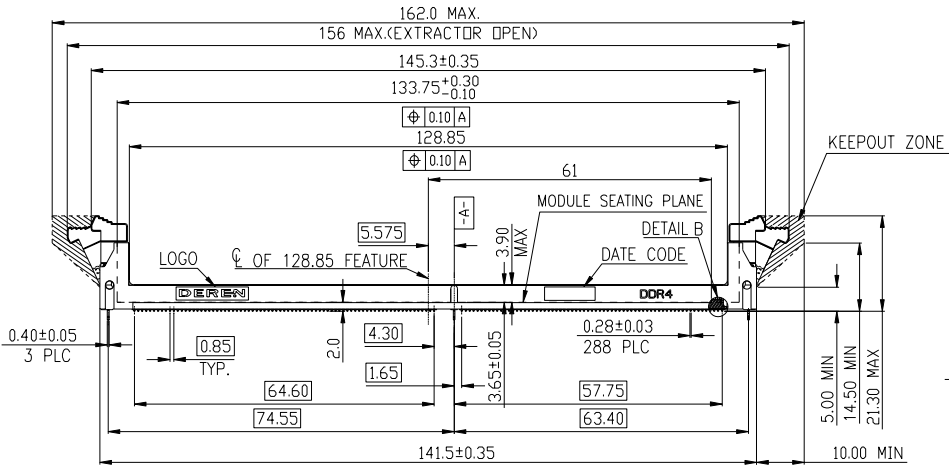

DIM	TOL	DIM	TOL
.x	±0.35	.x	±2"
.x	±0.25	.x	±1"
.xx	±0.20		
.xxx	±0.15		

**DEREN**  
SHENZHEN DEREN ELECTRONIC CO., LTD

DRAW NO. SC2006898	DESIGN: ZC.XIE	DATE: 07/06'21	TITLE: DDR4 288P SMT BIG EAR TYPE
	CHECK: Bill Lin	DATE: 07/06'21	
REV. A	APPROVAL: Smark Huo	DATE: 07/06'21	SHEET: 1/4
			SCALE: 1:1 UNIT: mm

**HF**

Halogen Free

REV.	ECN NO.	LOCATION	DESCRIPTION	DATE	DESIGN
A			INITIAL RELEASE	07/06'21	ZC.XIE

TABLE 1:

PART NUMBER	PLATING	HOUSING COLOR	EXTRACTOR COLOR	FORK LOCK TYPE
568Q07-023H	Au30u"	BLACK	BLACK	3PCS SOLDER TAB
568Q07-024H	Au30u"	BLACK		3PCS BOARD LOCK
568Q07-021H	Au30u"	WHITE		3PCS SOLDER TAB
568Q07-022H	Au30u"	WHITE		3PCS BOARD LOCK
568Q07-013H	Au15u"	WHITE		3PCS SOLDER TAB
568Q07-014H	Au15u"	WHITE		3PCS BOARD LOCK
568Q07-015H	Au15u"	BLACK		3PCS SOLDER TAB
568Q07-016H	Au15u"	BLACK		3PCS BOARD LOCK
568Q07-017H	GF	WHITE		3PCS SOLDER TAB
568Q07-018H	GF	WHITE		3PCS BOARD LOCK
568Q07-019H	GF	BLACK		3PCS SOLDER TAB
568Q07-020H	GF	BLACK		3PCS BOARD LOCK
568Q07-001H	Au30u"	BLACK	WHITE	3PCS SOLDER TAB
568Q07-002H	Au30u"	BLACK		3PCS BOARD LOCK
568Q07-003H	Au30u"	WHITE		3PCS SOLDER TAB
568Q07-004H	Au30u"	WHITE		3PCS BOARD LOCK
568Q07-005H	Au15u"	WHITE		3PCS SOLDER TAB
568Q07-006H	Au15u"	WHITE		3PCS BOARD LOCK
568Q07-007H	Au15u"	BLACK		3PCS SOLDER TAB
568Q07-008H	Au15u"	BLACK		3PCS BOARD LOCK
568Q07-009H	GF	WHITE		3PCS SOLDER TAB
568Q07-010H	GF	WHITE		3PCS BOARD LOCK
568Q07-011H	GF	BLACK		3PCS SOLDER TAB
568Q07-012H	GF	BLACK		3PCS BOARD LOCK

TABLE 2:

PART NUMBER	PLATING	HOUSING COLOR	EXTRACTOR COLOR	FORK LOCK TYPE			
568Q07-046H	Au30u"	BLUE	WHITE	3PCS SOLDER TAB			
568Q07-028H	Au30u"		WHITE	3PCS BOARD LOCK			
568Q07-055H	Au30u"		BLUE	3PCS SOLDER TAB			
568Q07-037H	Au30u"		BLUE	3PCS BOARD LOCK			
568Q07-047H	Au15u"		WHITE	3PCS SOLDER TAB			
568Q07-029H	Au15u"		WHITE	3PCS BOARD LOCK			
568Q07-056H	Au15u"		BLUE	3PCS SOLDER TAB			
568Q07-038H	Au15u"		BLUE	3PCS BOARD LOCK			
568Q07-048H	GF		WHITE	3PCS SOLDER TAB			
568Q07-030H	GF		WHITE	3PCS BOARD LOCK			
568Q07-057H	GF		BLUE	3PCS SOLDER TAB			
568Q07-039H	GF		BLUE	3PCS BOARD LOCK			
568Q07-061H	Au30u"	BLACK	BLUE	2PSC SOLDER TAB AT BOTH ENDS AND 1PCS BOARD LOCK IN THE MINDDL E			
568Q07-062H	Au15u"						
568Q07-063H	GF	BLACK	BLACK				
568Q07-064H	Au30u"						
568Q07-065H	Au15u"						
568Q07-066H	GF						

DIM	TOL	DIM	TOL
x.	±0.35	x.	±2°
.x	±0.25	.x	±1°
.xx	±0.20		
.xxx	±0.15		

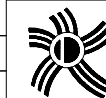

**DEREN**  
SHENZHEN DEREN ELECTRONIC CO., LTD

CUSTOMER DRAWING		DATE	TITLE: DDR4 288P SMT BIG EAR TYPE	
DESIGN:	ZC.XIE	07/06'21	P/N: SEE TABLE	
CHECK:	Bill Lin	07/06'21	SHEET: 2/5	
APPROVAL:	Smark Huo	07/06'21	SCALE: 1:1	UNIT: mm

DRAW NO.  
SC2006898

REV. A

REV.	ECN NO.	LOCATION	DESCRIPTION	DATE	DESIGN
A			INITIAL RELEASE	07/06'21	ZC.XIE

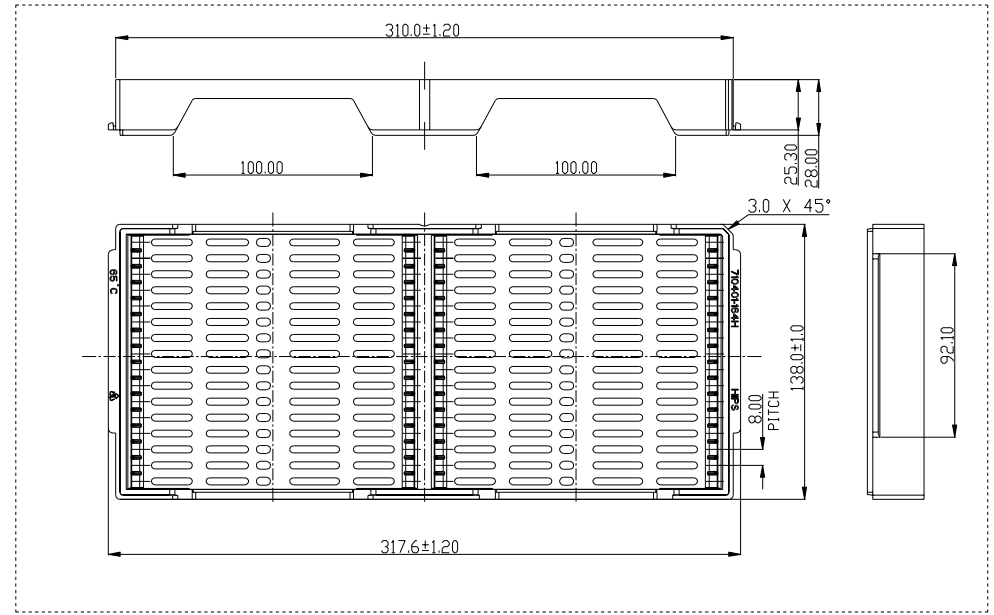
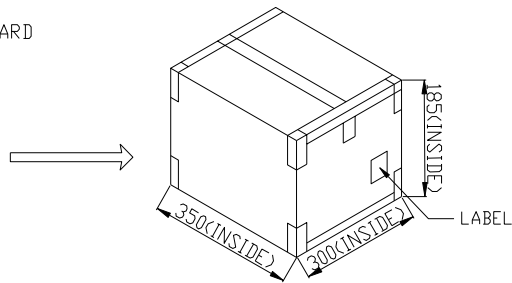
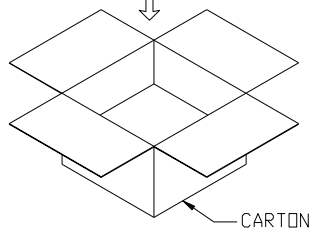
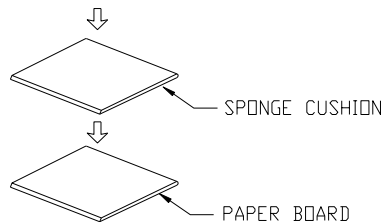
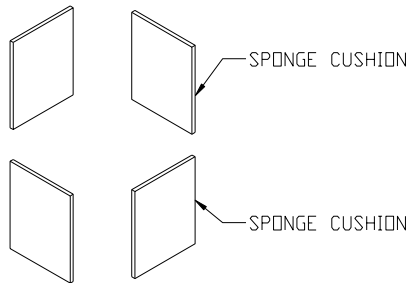
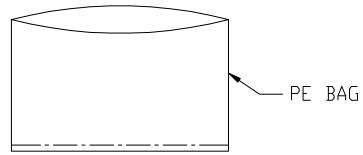
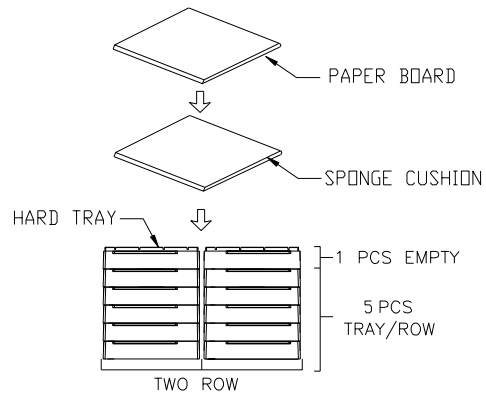

HARD TRAY VIEW

4.35kg	1.86kg	32	10	320
GROSS WEIGHT	NET WEIGHT	PCS/ TRAY	TRAY/ BOX	PCS/ BOX

DIM	TOL	DIM	TOL
X.	±1.00	X.	
.X	±0.50	.X	
.XX	±0.35		



**DEREN**  
SHENZHEN DEREN ELECTRONIC CO., LTD

DRAW NO.  
SC2006898

CUSTOMER DRAWING	DATE
DESIGN: ZC.XIE	07/06'21
CHECK: Bill Lin	07/06'21
APPROVAL: Smark Huo	07/06'21

TITLE: DDR4 288P SMT BIG EAR TYPE
P/N: SEE TABLE
SHEET: 4/4
SCALE: 1:1
UNIT: mm