

HF
Halogen Free

REV	ECN NO.	LOCATION	DESCRIPTION	DATE	DESIGN
A			UPDATE	4/20'21	ZC.XIE

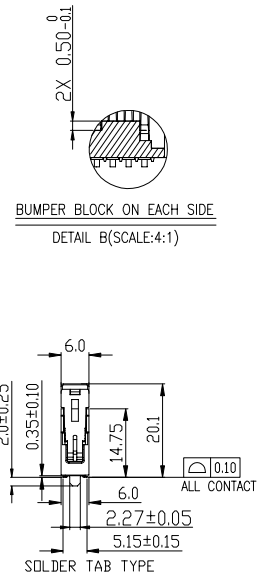

- NOTES:
- PRODUCT MUST MEET CONTROLLED SUBSTANCES SPEC. ROHS 2.0
 - MATERIAL:
 - HOUSING: NYLON , UL94V-0; COLOR: SEE P/N INFORMATION.
 - EXTRACTOR: NYLON ,UL94V-0; COLOR: SEE P/N INFORMATION.
 - CONTACT: COPPER ALLOY .
 - FORK LOCK: STAINLESS STEEL.
 - METAL SHEET: STAINLESS STEEL
 - FINISH:
 - CONTACT:
 - GOLD PLATING(SEE SEE P/N INFORMATION.) ON CONTACT AREA.
 - 2.0um[80u"] MIN. MATTE-TIN PALTING ON SOLDER TAIL AREA.
 - 2.25um[90u"] MIN. NICKEL ON CONTACT AREA,
 - 1.27um[50u"] MIN. NICKEL ON OTHER AREA.
 - FORK LOCK:
 - MATTE TIN PALTING 80u"Min ON SOLDER TAIL AREA.
 - 50u" MIN. NICKEL UNDERPLATING OVERALL.
 - REFLOW SOLDER CAPABLE TO 260°C MAX. 10S.
 - MECHANICAL SPECIFICATION:
 - MATING FORCE: 106.8N MAX.
 - UNMATING FORCE: 19.77N MIN.
 - DURABILITY: 25 MATING AND UNMATING CYCLES
 - ELECTRICAL SPECIFICATION
 - CONTACT RESISTANCE: INITIAL:10 MILLIOHMS MAX., CONTACT RESISTANCE: FINAL: CHANGE 10 MILLIOHMS MAX..
 - CURRENT RATING: 0.75AMPS MAX.
 - INSULATION RESISTANCE: 1 MEGOHMS MIN. AT 500VAC
 - DIELECTRIC WITHSTAND VOLTAGE: 500VAC MIN. FOR ONE MINUTE.
 - ENVIRONMENT SPECIFICATION
 - OPERATING TEMPERATURE: -55°C TO +85°C.
 - SOLDERABILITY: PASSED PER EIA-364-52, CLASS 2, CATEGORY 3.
 - VIBRATION: PASSED PER EIA-364-28.
 - HUMIDITY: PASSED PER EIA-364-31.
 - THERMAL SHOCK: PASSED PER EIA-364-32.
 - MECHANICAL SHOCK: PASSED PER EIA-364-27.
 - PART NUMBER INFORMATION:

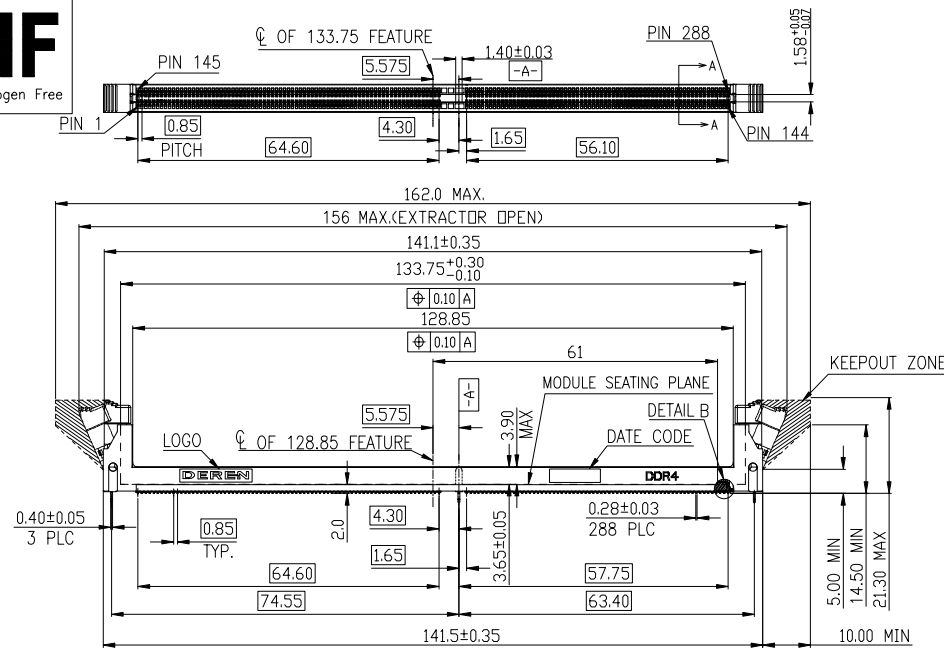
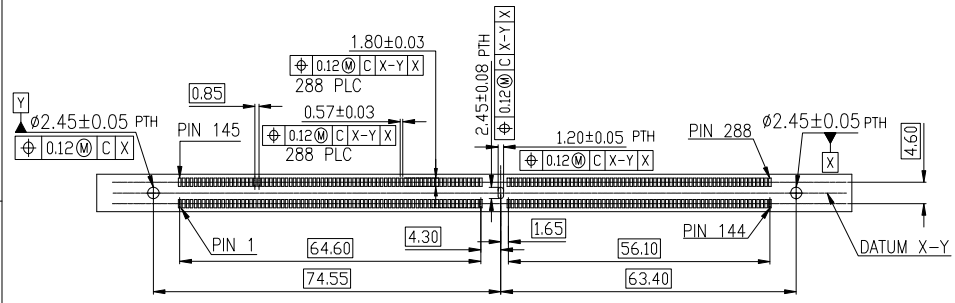

NOTE:
RECOMMENDED STENCIL THINKNESS NO LESS THAN 0.15MM

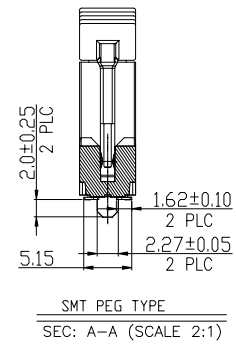

568QD0-002 H X X X X

GREEN CODE:
H: HALOGEN FREE

PLATING CODE:
1:GOLD FLASH
2:GOLD 15u"
3:GOLD 30u"

HOUSING COLOR CODE:
1: BLACK
2: WHITE
3: BLUE

PACKAGE & PICKUP CODE:
1: HARD TRAY PACKING,WITH CAP
2: HARD TRAY PACKING,WITHOUT CAP/MYLAR
3: HARD TRAY PACKING, WITH MYLAR

FORK LOCK TYPE CODE:
1: THREE SOLDER TAB
2: THREE BOARD LOCK
3: ONE BOARD LOCK IN MINDLE , TWO SOLDER TAB AT BOTH ENDS

EXTRACTOR COLOR CODE:
1: BLACK
2: WHITE
3: BLUE

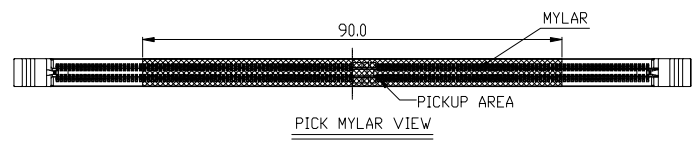
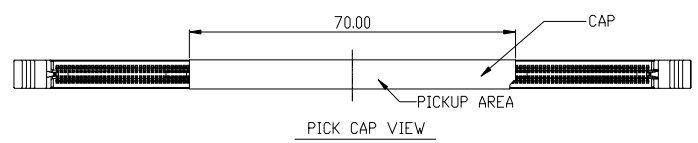

DIM	TOL	DIM	TOL
x.	±0.35	x.	±2'
.x	±0.25	.x	±1'
.xx	±0.20		
.xxx	±0.15		



DEREN
SHENZHEN DEREN ELECTRONIC CO., LTD

DRAW NO.	SC2107275	DATE	4/20'21	TITLE:	DDR4 288PIN SMALL BIG EXTRACTOR SOLDER TAB
DESIGN:	ZC.XIE	DATE	4/20'21	P/N:SEE P/N INFORMATION	
CHECK:	Bill Lin	DATE	4/20'21	SHEET:	1/4
APPROVAL:	Smak Huo	DATE	4/20'21	SCALE:	1:1
REV.	A			UNIT:	mm



FORK LOCK TYPE :

REV.	ECN NO.	LOCATION	DESCRIPTION	DATE	DESIGN
A			UPDATE	4/20'21	ZC.XIE

TYPE 1

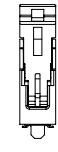
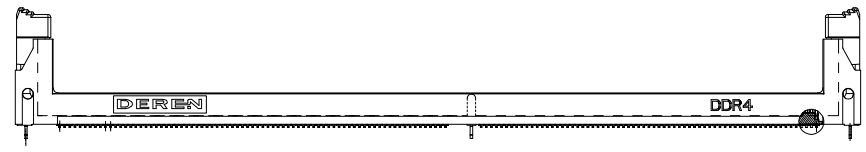

TYPE 2

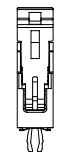
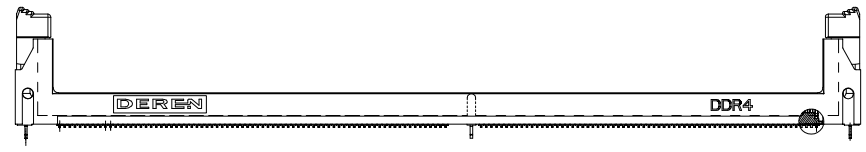

TYPE 3

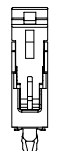
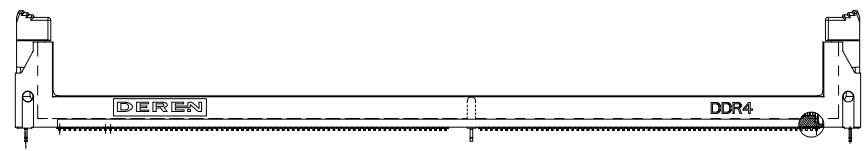

TYPE 4

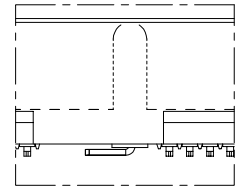
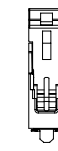
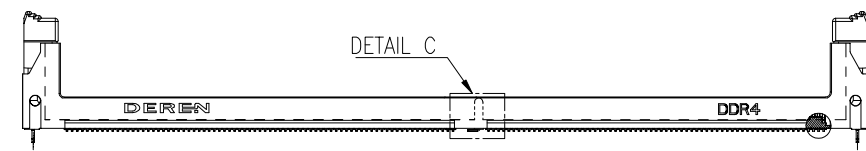

DETAIL C(SCALE:4:1)

DIM	TOL	DIM	TOL
x.	±0.35	x.	±2°
.x	±0.25	.x	±1°
.xx	±0.20		
.xxx	±0.15		



DEREN
SHENZHEN DEREN ELECTRONIC CO., LTD

DRAW NO.
SC2107275

CUSTOMER DRAWING	DATE
DESIGN: ZC.Xie	4/20'21
CHECK: Bill Lin	4/20'21
APPROVAL: Smark Huo	4/20'21

TITLE: DDR4 288PIN SMT BIG EXTRACTOR SOLDER TAB		
P/N: SEE TABLE		
SHEET: 2/4		
SCALE: 1:1	UNIT: mm	

HF
Halogen Free

REV.	ECN NO.	LOCATION	DESCRIPTION	DATE	DESIGN
A			UPDATE	4/20'21	ZC.XIE

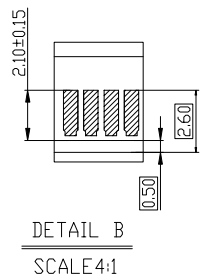
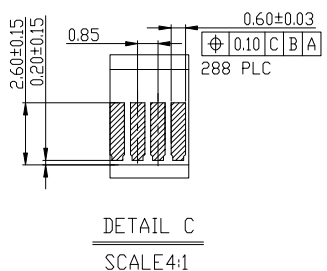
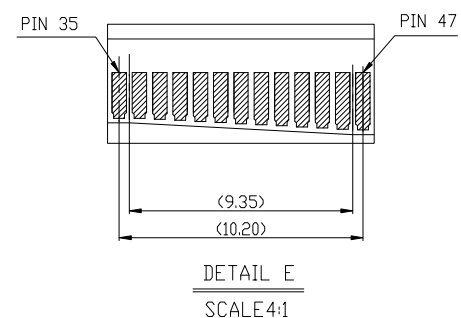
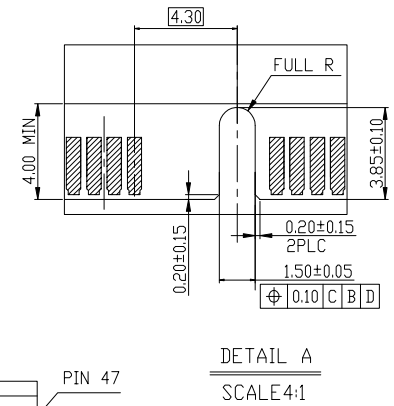
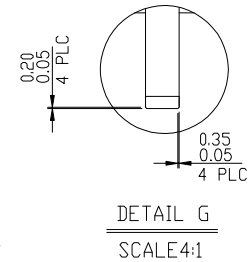
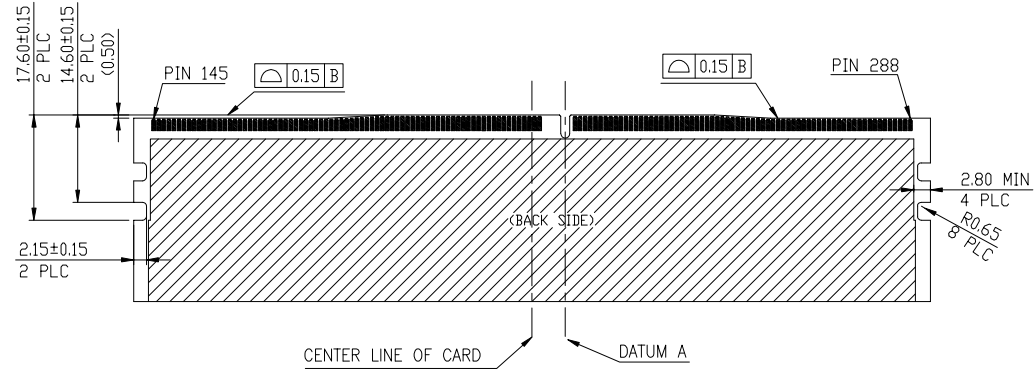
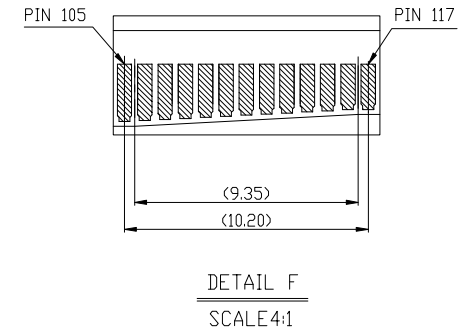
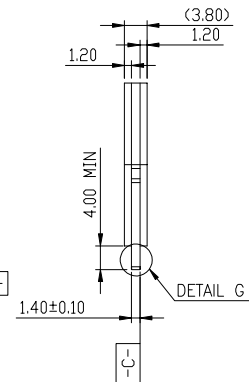
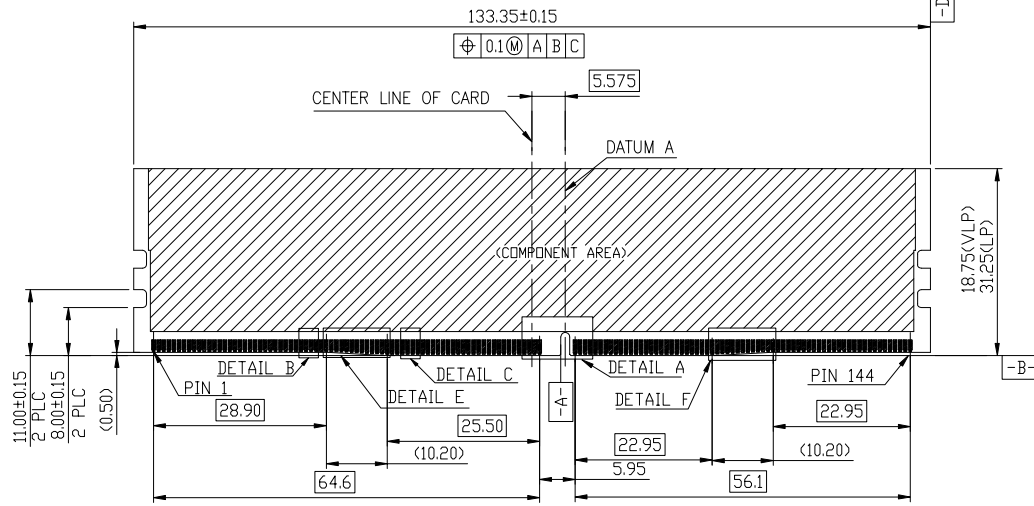

DIM	TOL	DIM	TOL
.x	±0.35	.x	±2*
.x	±0.25	.x	±1*
.xx	±0.20		
.xxx	±0.15		



DEREN
SHENZHEN DEREN ELECTRONIC CO., LTD

DRAW NO.
SC2107275
REV. A

CUSTOMER DRAWING
DESIGN: ZC.Xie
CHECK: Bill Lin
APPROVAL: Smark Huo
DATE: 4/20'21

TITLE: DDR4 288PIN SMT BIG EXTRACTOR SOLDER TAB
 P/N: SEE TABLE
 SHEET: 3/4
 SCALE: 1:1
 UNIT: mm

REV.	ECN NO.	LOCATION	DESCRIPTION	DATE	DESIGN
A			UPDATE	4/20'21	ZC.XIE

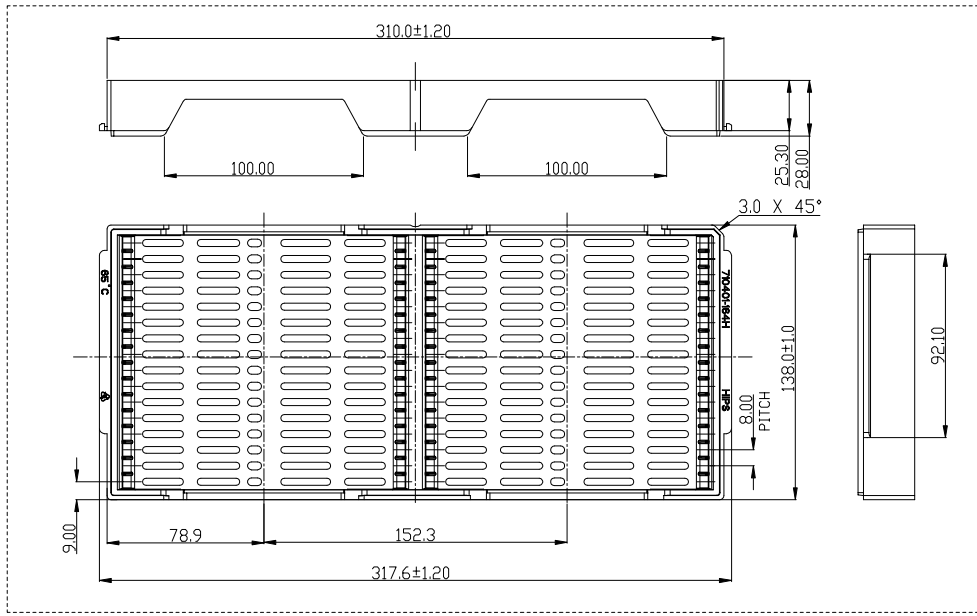
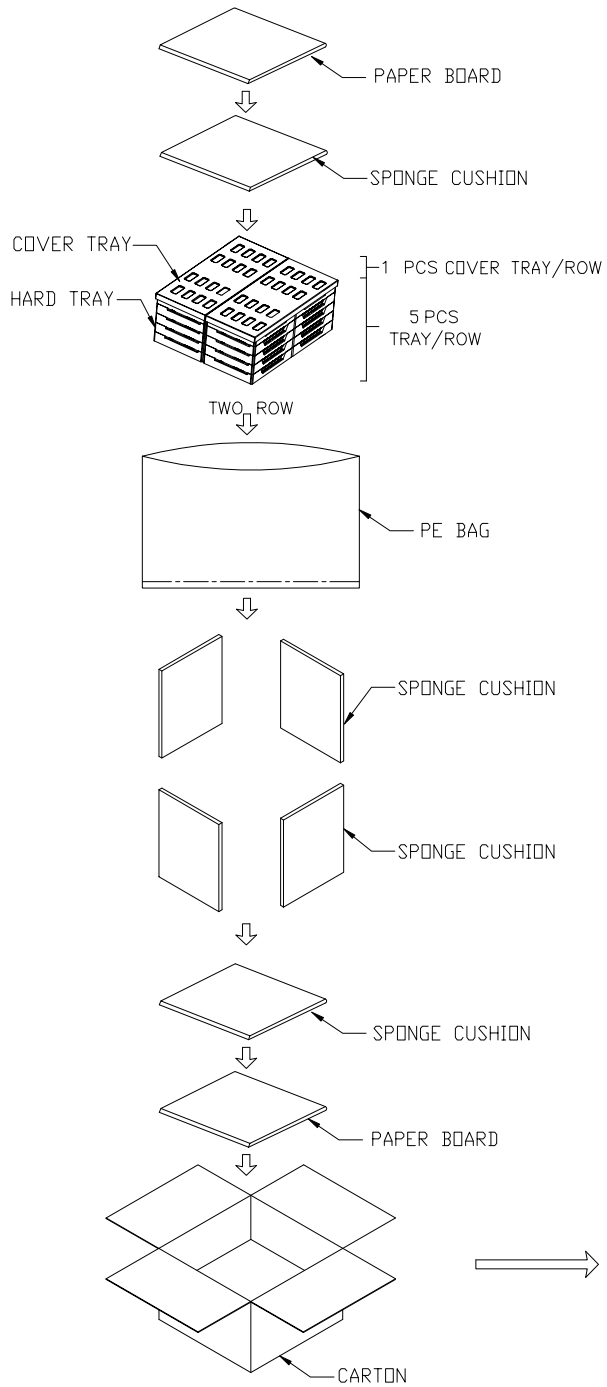

HARD TRAY VIEW

4.35kg	1.86kg	32	10	320
GROSS WEIGHT	NET WEIGHT	PCS/ TRAY	TRAY/ BOX	PCS/ BOX

DIM	TOL	DIM	TOL
X.	±1.00	X.	
.X	±0.50	.X	
.XX	±0.35		



DEREN
SHENZHEN DEREN ELECTRONIC CO., LTD

DRAW NO. SC2107275	DESIGN: ZC.Xie	DATE 4/20'21	TITLE: DDR4 288PIN SMT BIG EXTRACTOR SOLDER TAB
REV. A	CHECK: Bill Lin	4/20'21	P/N: SEE P/N INFORMATION
APPROVAL: Smak Huo	4/20'21	SHEET: 4/4	SCALE: 1:1 UNIT: mm

