

# HF

Halogen Free

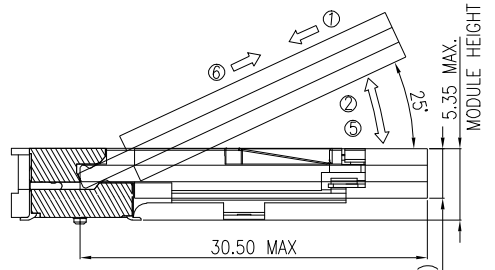
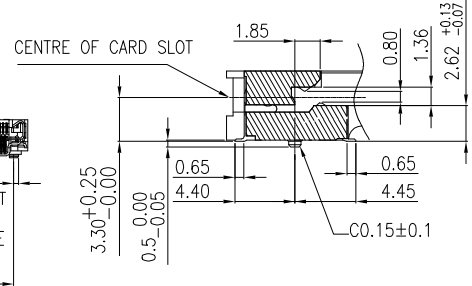
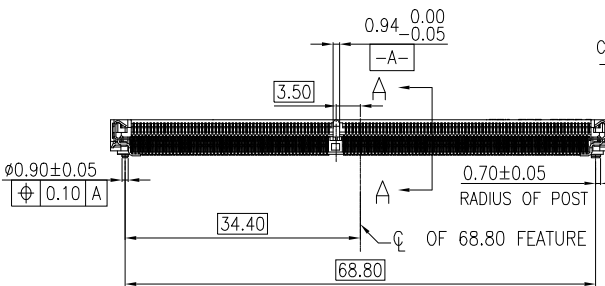
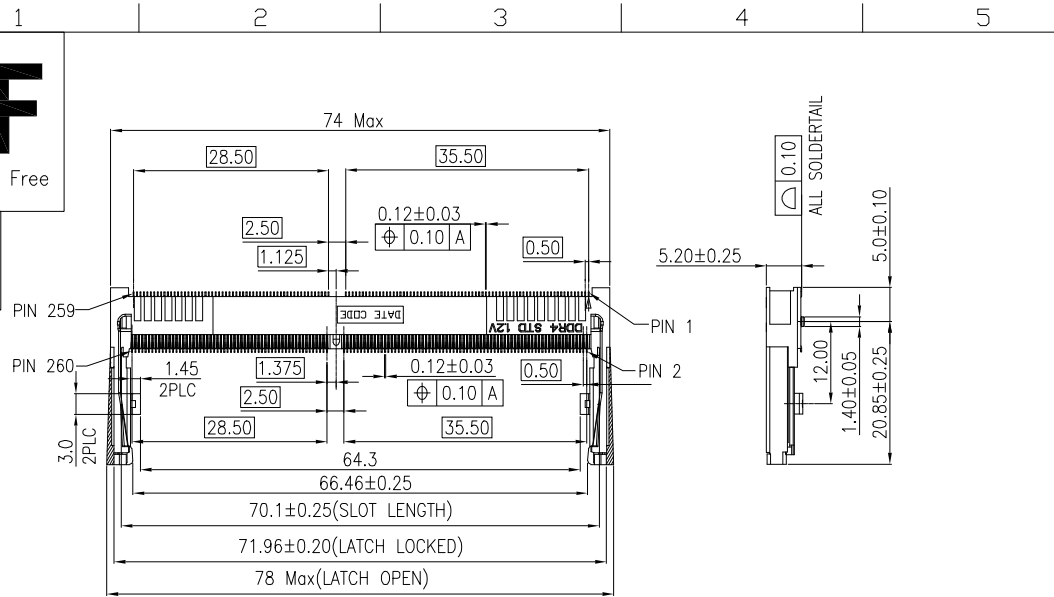

MATING: ① INSERTING(25°) → ② ROTATING → ③ FIXED  
 UNMATING: ④ UNFIXED → ⑤ ROTATING → ⑥ WITHDRAWING

REV.	ECN NO.	LOCATION	DESCRIPTION	DATE	DESIGN
A2			REVISE	8/18'15	Wang.lie
B			REVISE	9/29'16	Wang.lie

NOTES:  
 1.MATERIAL:  
 1.1 HOUSING:LCP,UL 94V-0,COLOR:BLACK.  
 1.2 CONTACT:PHOSPHOR BRONZE.  
 1.3 SOLDER PEG AND LATCH:STAINLESS STEEL.  
 2. FINISH:  
 2.1 CONTACT: 50u" MIN NICKEL UNDERPLATED ALL OVER.  
 GOLD FLASH PLATING ON SOLDER TAIL.  
 GOLD PLATING (THICKNESS SEE TABLE) ON CONTACT AREA.  
 2.2 SOLDER PEG:  
 50u" MIN NICKEL UNDERPLATED ALL OVER.  
 AU 2u" MAX ON SOLDER TAIL.  
 3. DATE CODE : YYWWDLX  
 YY: YEAR (09: 2009)  
 WW: WEEK (25: THE 25TH WEEK)  
 D: DAY (1~7: SUNDAY~SATURDAY)  
 L: LINE NUMBER OF ASSEMBLY (A: LINE A)  
 X: MANUFACTURE CODE  
 4. PART NUMBER DESCRIPTION:  
 40-42272-2600XRHF

HALOGEN CODE:  
 HF:HALOGEN FREE  
 R: TAPE & REEL PACKING  
 PLATING CODE:  
 1: GF 2: Au5u" 3: Au10u"  
 4: Au15u" 5: Au30u"  
 0: DR LOGO  
 1: NO LOGO  
 PIN NUMBER CODE: 260 PINS

TABLE 2

DIM	TOL	DIM	TOL
30u" Au	40-42272-26005RHF	.x	±0.35
15u" Au	40-42272-26004RHF	.xx	±0.25
10u" Au	40-42272-26003RHF		
5u" Au	40-42272-26002RHF	.xxx	±0.15
GF	40-42272-26001RHF		
PLATING THICKNESS		DEREN P/N	

DIM	TOL	DIM	TOL
x.'	±3'	x.'	±2'
		.xx'	±1'

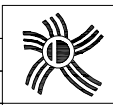

**DEREN**  
 SHENZHEN DEREN ELECTRONIC CO., LTD

CUSTOMER DRAWING	DATE	TITLE: DDR4 SO DIMM 260P 5.2H STD C-DWG
DESIGN: Wang.lie	9/29'16	P/N: SEE TABLE 2
CHECK: Bill.lin	9/29'16	SHEET: 1/3
APPROVAL: Bill.lin	9/29'16	SCALE: 1:1 UNIT: mm

DRAW NO. T-15-0256  
 REV. B

# HF

Halogen Free



REV.	ECN NO.	LOCATION	DESCRIPTION	DATE	DESIGN
A2			REVISE	8/18'15	Wang.lie
B			REVISE	9/29'16	Wang.lie

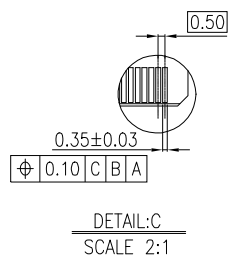
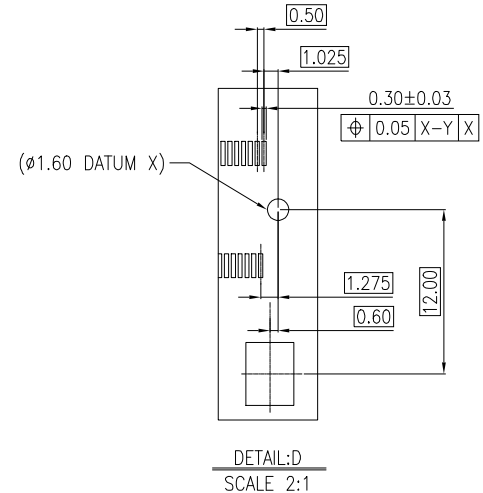
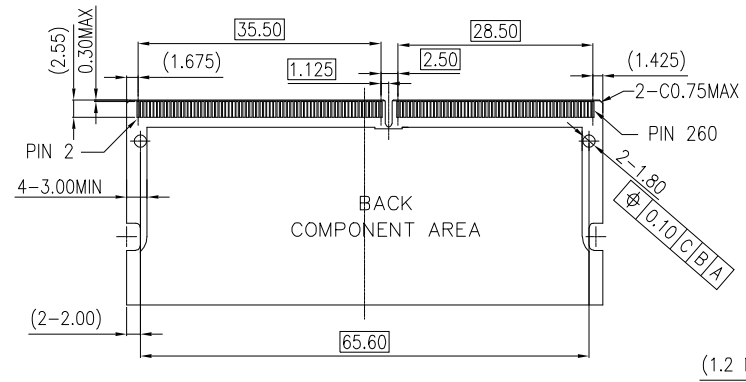
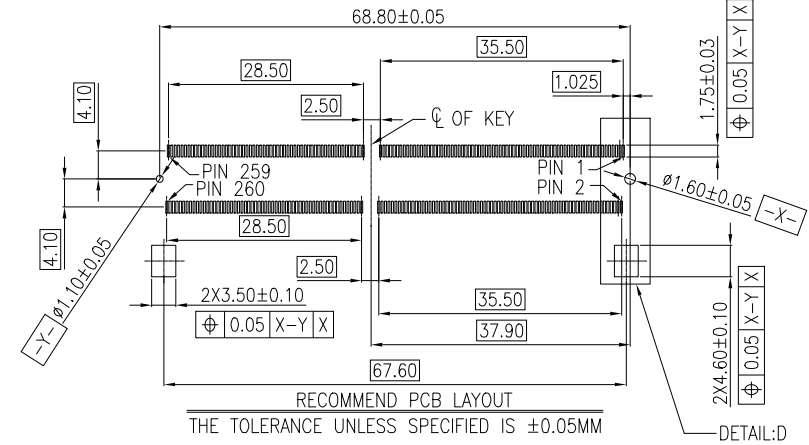
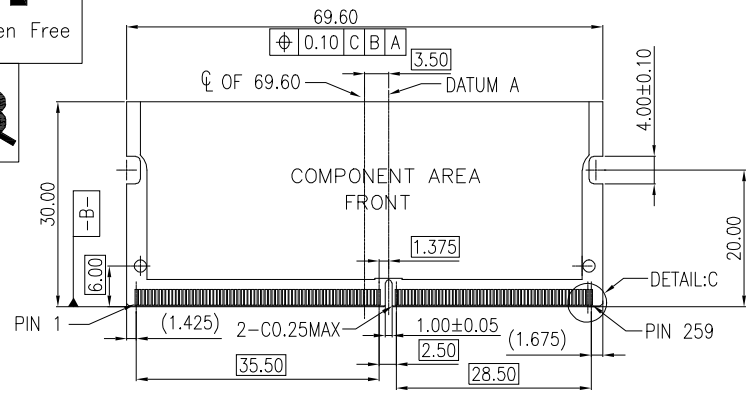

DIM	TOL	DIM	TOL
.x	$\pm 0.35$	x.'	$\pm 3'$
.xx	$\pm 0.25$	.x'	$\pm 2'$
.xxx	$\pm 0.15$	.xx'	$\pm 1'$



**DEREN**  
 SHENZHEN DEREN ELECTRONIC CO., LTD

CUSTOMER DRAWING	DATE	TITLE: DDR4 SD DIMM 260P 52H STD C-DWG
DESIGN: Wang.lie	9/29'16	P/N: SEE TABLE 2
CHECK: Bill.lin	9/29'16	SHEET: 2/3
REV. B	APPROVAL: Bill.lin	9/29'16
		SCALE: 1:1 UNIT: mm

**HF**

Halogen Free

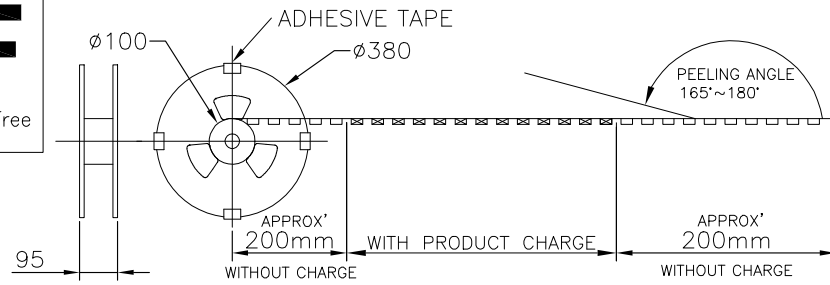

REV.	ECN NO.	LOCATION	DESCRIPTION	DATE	DESIGN
A2			REVISE	8/18'15	Wang.lie
B			REVISE	9/29'16	Wang.lie

PULL OUT DIRECTION →

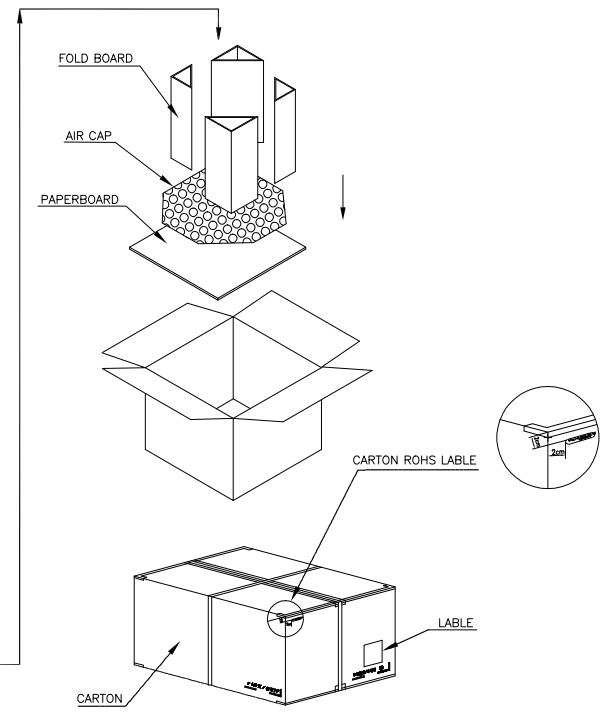
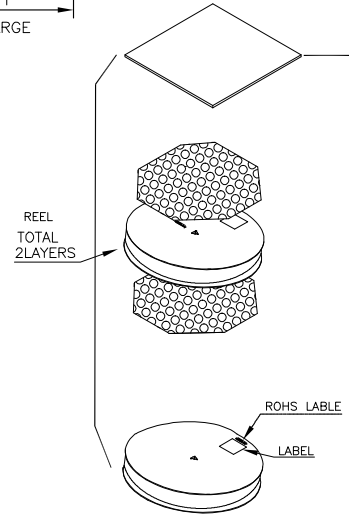
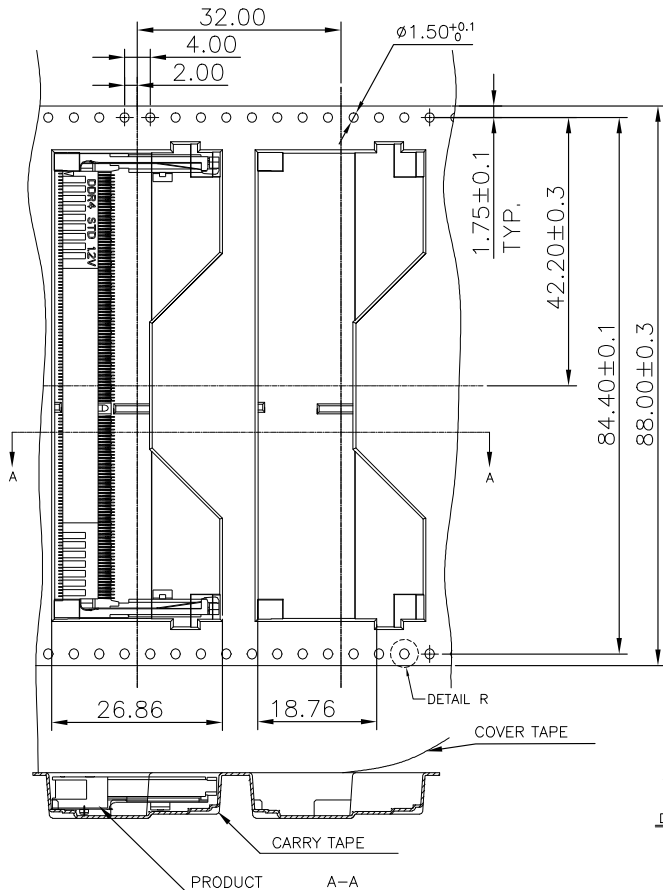

400	2	800	40-42272-2600XRHF
PCS/REEL	REEL/CARTON	PCS/CARTON	PART NUMBER

DIM	TOL	DIM	TOL
.x	±0.35	x.'	±3'
.xx	±0.25	.x'	±2'
.xxx	±0.15	.xx'	±1'



**DEREN**  
SHENZHEN DEREN ELECTRONIC CO., LTD

CUSTOMER DRAWING	DATE	TITLE: DDR4 SD DIMM 260P 5.2H STD C-DWG
DESIGN: Wang.lie	9/29'16	P/N: SEE TABLE 2
CHECK: Bill.lin	9/29'16	SHEET: 3/3
REV. B	APPROVAL: Bill.lin	9/29'16
		SCALE: 1:1 UNIT: mm