

HF
Halogen Free



REV.	ECN NO.	LOCATION	DESCRIPTION	DATE	DESIGN
X1			PRELIMINARY	2022.03.15	Chen

NOTES:
 PRODUCT MEETS CONTROLLED SUBSTANCES SPEC. ROHS 2.0
 1. MATERIAL:
 1.1 HOUSING: HIGH TEMPERATURE PLASTIC, UL94V-0; COLOR: BLACK
 1.2 OTHER CONTACT: COPPER ALLOY
 1.3 EAR: HIGH TEMPERATURE PLASTIC, UL94V-0; COLOR: BLACK
 1.4 GND CONTACT: COPPER ALLOY
 1.5 HOOK: STAINLESS STEEL
 1.6 GROUND PLATE: STAINLESS STEEL
 2. FINISH:
 2.1 OTHER CONTACT: GOLD PLATING(SEE PART NUMBER) ON CONTACT AREA.
 2.54um[100u"] MIN. MATTE-TIN PLATING ON SOLDER TAIL AREA.
 1.27um[50u"] MIN. NICKEL UNDERPLATING OVER ALL.
 2.2 GND CONTACT: 0.076um[3u"]Au PLATING ON CONTACT AREA.
 2.54um[100u"] MIN. MATTE-TIN PLATING ON SOLDER TAIL AREA.
 1.27um[50u"] MIN. NICKEL UNDERPLATING OVERALL.
 2.3 HOOK: 1.27um[50u"] MIN. NICKEL UNDERPLATING OVER ALL, 100u"
 MATTE TIN PLATING OVER NICKEL AT TAIL.
 2.4 SHELL: 30u" MIN. NICKEL PLATING OVERALL
 3. RECOMMENDED PROCESS: IR REFLOW 260±5°, 3~5s
 4. DATE CODE : YYWDLX (YY: YEAR, WW: WEEK, D: DAY,
 L: PRODUCTION LINE CODE, X: MANUFACTURE CODE)
 5. PART NUMBER DESCRIPTION:

564ZD4 -018H * * * *

- PACKING CODE: 1: TRAY
2: REEL
3: HARD TRAY
- HOUSING COLOR: 1: BLACK 2: WHITE 3: BLUE
- RIDGE&POS CODE:
1. HOUSING POST&WITH RIDGE
2. HOUSING POST&WITHOUT RIDGE
3. BOARD LOCK&WITH RIDGE
4. BOARD LOCK&WITHOUT RIDGE
- PLATING CODE: 1: G/F
2: 15u" Min
3: 30u" Min
- HALOGEN CODE: H: HALOGEN FREE

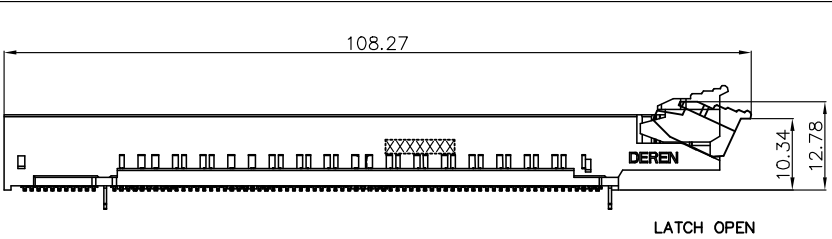
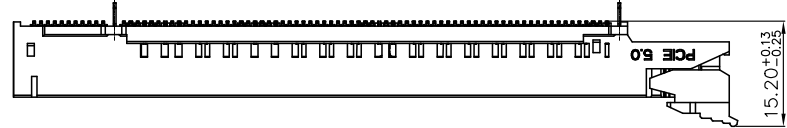
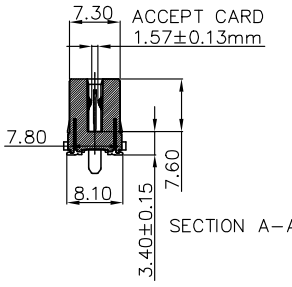
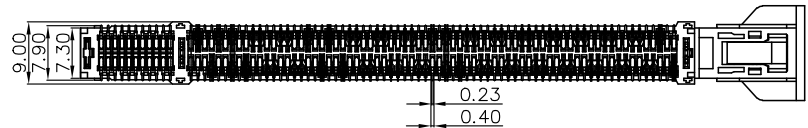
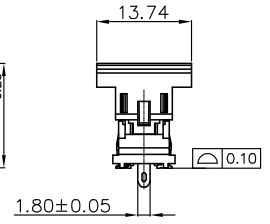
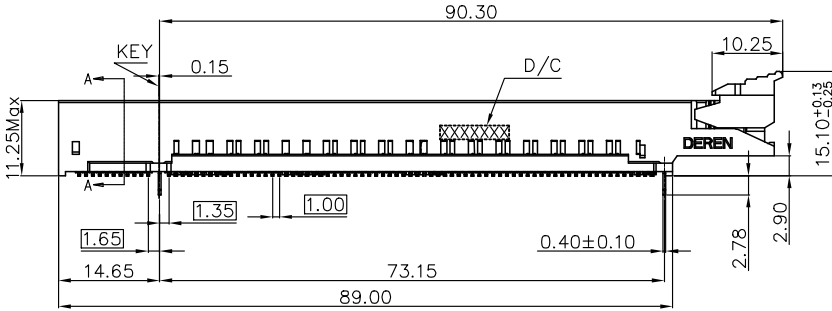
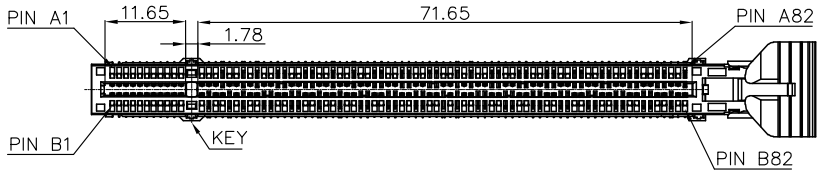
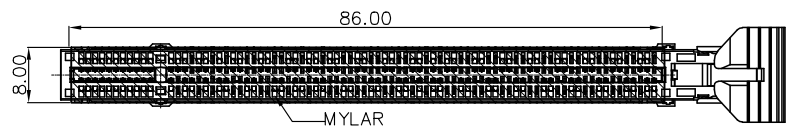

DIM	TOL	DIM	TOL
x.	±0.30	x.	±2'
.x	±0.25	.x	±1'
.xx	±0.20		



DEREN		SHENZHEN DEREN ELECTRONIC CO., LTD	
CUSTOMER DRAWING	DATE	TITLE: PCI-E 5.0 SMT TYPE 164PIN WITH EAR&DIP HOOK	
DESIGN: Chen	2022.03.15	P/N:	SEE TABLE
CHECK: Bill.Lin	2022.03.15	SHEET:	1/3
REV. X1	APPROVAL: Smark.Huo	2022.03.15	SCALE: 1:1 UNIT: mm

HF
Halogen Free

~~Pb~~

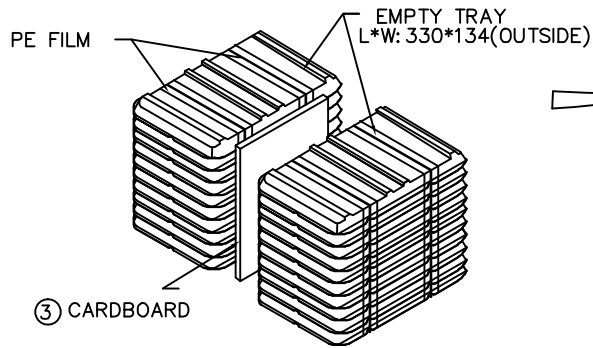
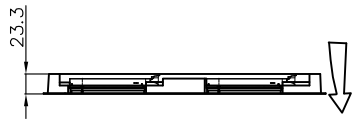
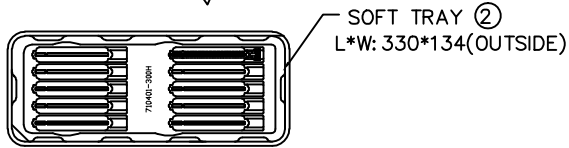

8	EPE		350*160*10mm	2
7	EPE		265*180*10mm	2
6	EPE		350*285*10mm	2
5	CARTON	700101-083H	365*300*215mm	1
4	BAG	55-41001-02	600*600*0.05mm	1
3	CARDBOARD		330*165mm	1
2	SOFT TRAY	-	330*134mm	22
1	CONN	-	-	200pcs
NO.	PART NAME	PART NUMBER	SPEC.	QTY

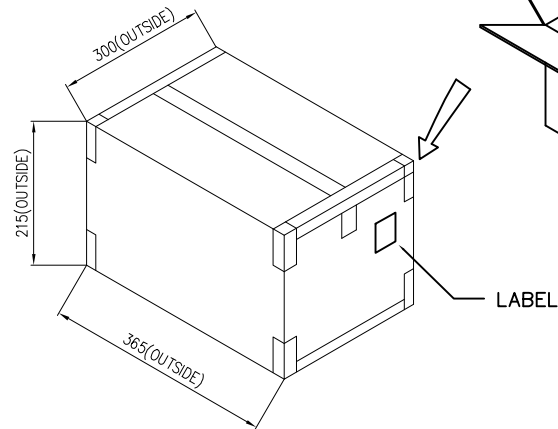
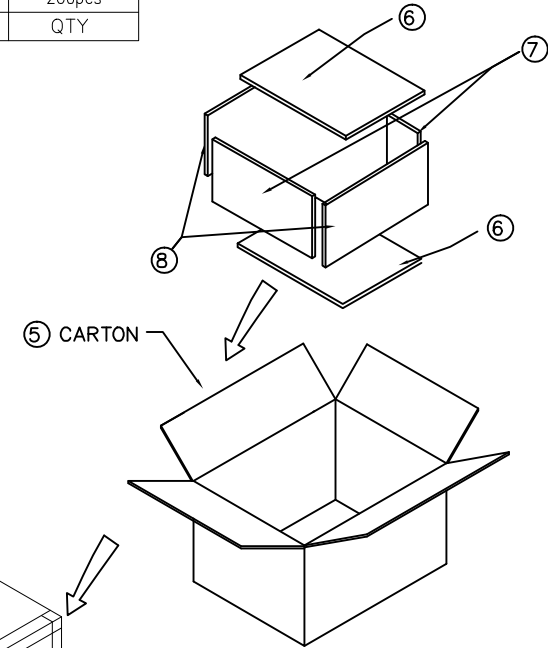
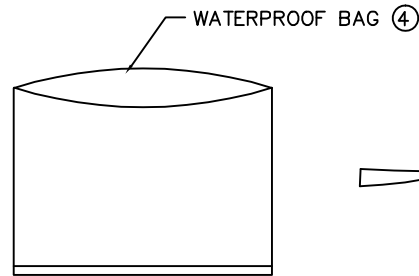

- NOTE:
1. PUT THE PRODUCTS INTO TRAY WITH DIRECTION AS THE LEFT SKETCH SHOWN, 10pcs/TRAY, 11 TRAYS STACKED UP PER BUNDLE. THEN ADD AN EMPTY TRAY ON TOPSIDE.
 2. WIND THE TWO ENDS WITH PE FILM.
 3. PUT THE PRODUCTS BUNDLED INTO WATER-PROOF PE BAG, 2BUNDLES/BAG, THEN PUT INTO THE CARTON.
 4. SEAL OUTER CARTON WITH PACKING TAPE LIKE A 'H' SHAPE.
 5. PACKAGING QUANTITY: 200PCS/CARTON.

DIM	TOL	DIM	TOL
x.		x.	
.x		.x	
.xx			



DEREN
SHENZHEN DEREN ELECTRONIC CO., LTD

DRAW NO.
SC21072**

CUSTOMER DRAWING	DATE
DESIGN: Chen	2022.03.15
CHECK: Bill.Lin	2022.03.15
APPROVAL: Smark.Huo	2022.03.15

TITLE: PCI-E 5.0 SMT TYPE 164PIN WITH EAR&DIP HOOK	
P/N:	SEE TABLE
SHEET: 3/3	
SCALE: 1:1	UNIT: mm