

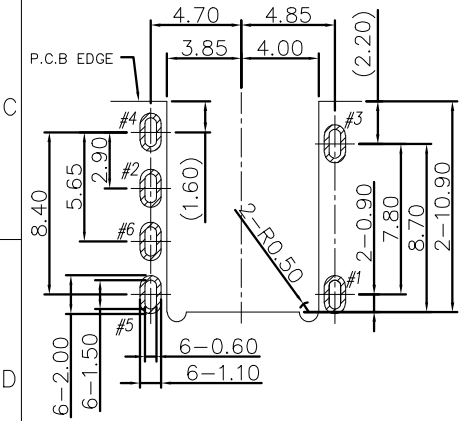

REV.	ECN NO.	LOCATION	DESCRIPTION	DATE	DESIGN
1			INITIAL RELEASE	2019.08.07	Alex_Z

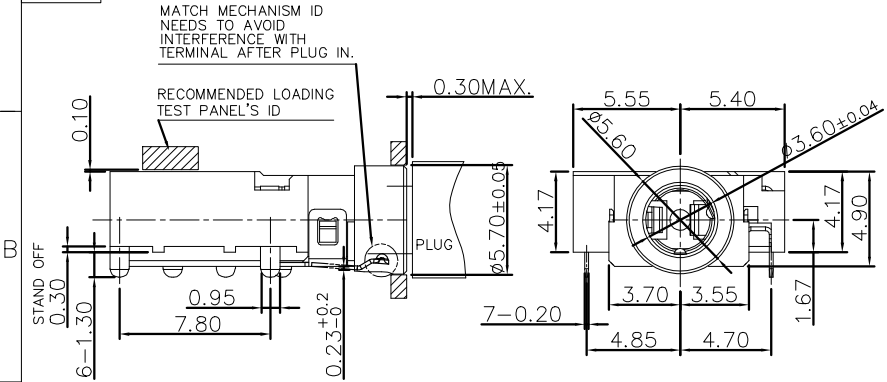

RECOMMENDED PCB LAYOUT  
TOP VIEW ; TOL:±0.05

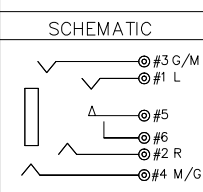
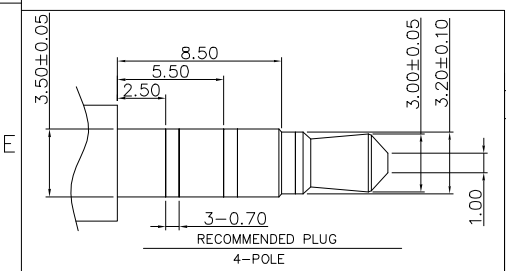
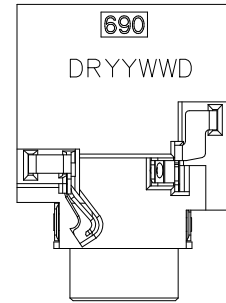
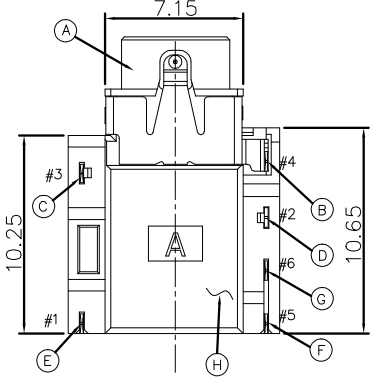

1. ELECTRICAL CHARACTERISTICS:
- 1-1. RATING: 12V 1A
  - 1-2. CONTACT RESISTANCE: 50mΩ MAX.(INITIAL)
  - 1-3. DIELECTRIC WITHSTANDING VOLTAGE: 500V AC FOR ONE MINUTE
  - 1-4. INSULATION RESISTANCE: 100MΩ MIN. MEASURED BY 500 VDC.
2. MECHANICAL CHARACTERISTICS:
- 2-1. INSERTION FORCE: 0.3~3.0Kgf;
  - 2-2. WITHDRAWAL FORCE: 0.3~3.0Kgf;
3. AFTER LIFE TEST, CONTACT RESISTANCE: 100mΩ MAX.
4. PACKAGING : TAPE & REEL.

5706B4-009[H]\*000[R]\*\*

- T: TRAY
- R: REEL
- CONTACTS LPATEING:
- 1: Au G/F 2: Au 5u"
- 3: Au 15u" 4: Au 30u"
- R:RoHS
- H:HALOGEN-FREE
- AUDIO

NO	DESCRIPTION	QTY	MATERIAL	PLATING & COLOR
H	SEPARATOR	1	LCP E130I UL 94V-0	BLACK
G	MAKE TERMINAL	1	C5210-EH 0.2T	GOLD FLASH ON CONTACT AREA; GOLD FLASH ON SOLDER AREA; ALL OVER 50u" NI
F	TRANSFER TERMINAL	1	C5210-EH 0.2T	GOLD FLASH ON CONTACT AREA; Matte Sn80u" ON SOLDER AREA; ALL OVER 50u" NI
E	TIP SPRING	1	C5210-EH 0.2T	
D	RING A	1	C5210-EH 0.2T	SEE"PART.NO." ON CONTACT AREA
C	RING B	1	C5210-EH 0.2T	Matte Sn80u" ON SOLDER AREA; ALL OVER 50u" NI
B	EARTH	1	C5210-EH T0.2	
A	BODY	1	HIGH TEMP.THERMOPLASTIC UL 94V-0	BLACK



**DEREN**  
SHENZHEN DEREN ELECTRONIC CO., LTD

DIM	TOL	DIM	TOL
x.	±0.30	x.	±2'
.x	±0.25	.x	±1'
.xx	±0.25		

DRAW NO.	DESIGN:	Alex_Z	DATE	2019.08.07	TITLE:	φ3.5mm AUDIO JACK 6P 1.67CH DIP CONN
***	CHECK:				P/N: SEE TABLE	
REV.	1	APPROVAL:			SHEET:	1/2
					SCALE:	1:1
					UNIT:	mm

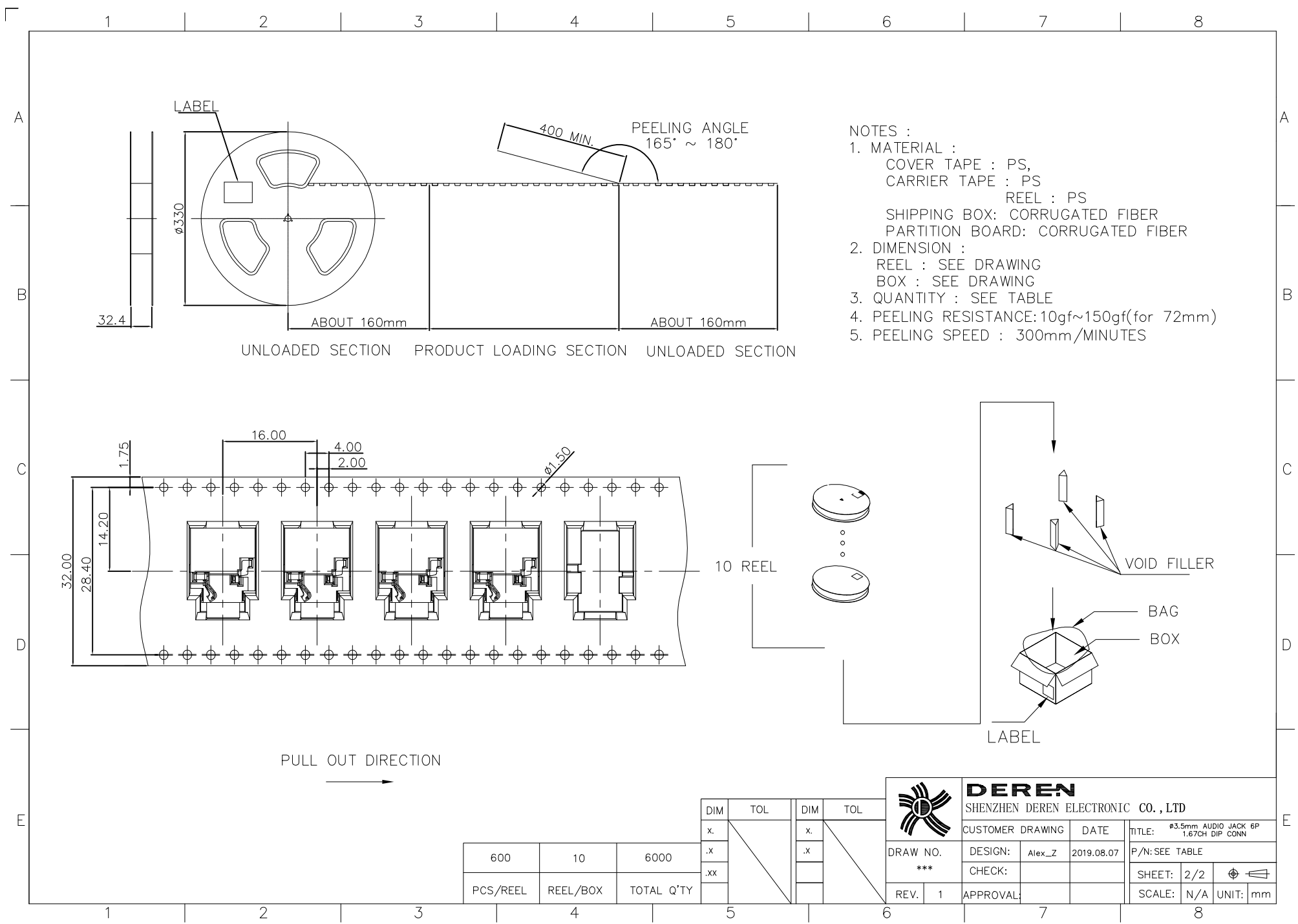

- NOTES :
- MATERIAL :  
 COVER TAPE : PS,  
 CARRIER TAPE : PS  
 REEL : PS  
 SHIPPING BOX: CORRUGATED FIBER  
 PARTITION BOARD: CORRUGATED FIBER
  - DIMENSION :  
 REEL : SEE DRAWING  
 BOX : SEE DRAWING
  - QUANTITY : SEE TABLE
  - PEELING RESISTANCE: 10gf~150gf(for 72mm)
  - PEELING SPEED : 300mm/MINUTES

DIM	TOL	DIM	TOL
x.		x.	
.x		.x	
.xx			

600	10	6000
PCS/REEL	REEL/BOX	TOTAL Q'TY

		<b>DEREN</b> SHENZHEN DEREN ELECTRONIC CO., LTD	
CUSTOMER DRAWING	DATE	TITLE: #3.5mm AUDIO JACK 6P 1.67GH DIP CONN	
DESIGN: Alex_Z	2019.08.07	P/N: SEE TABLE	
CHECK:		SHEET: 2/2	
REV. 1	APPROVAL:	SCALE: N/A	UNIT: mm